

chapter 8

Shoei Catalogue

仮囲い





SHOEI

安全鋼板

製品

品名	安全鋼板	品番	3m	質量	18.1kg
			2m		12.1kg

厚さ 1.2mm

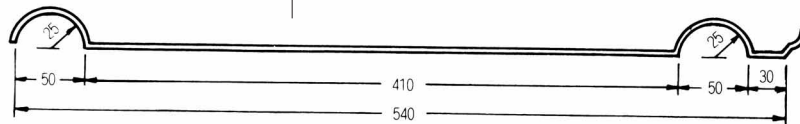

フックボルト取付位置 (取付穴10mm) 有効巾540mm

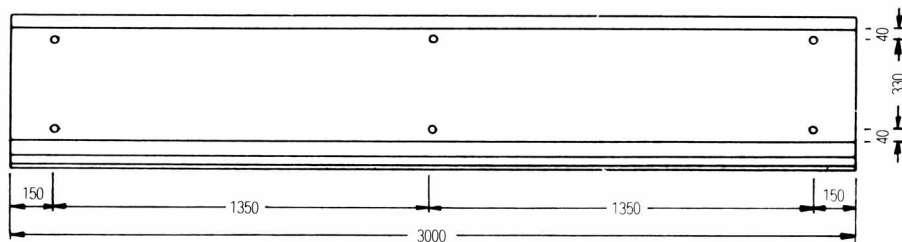
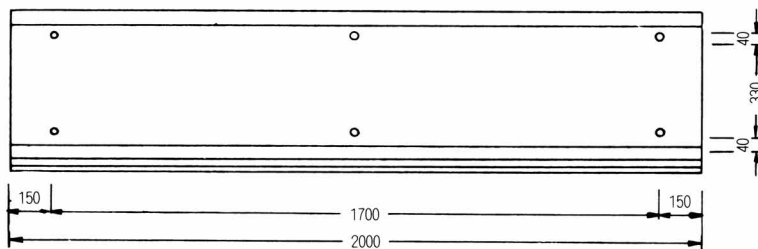

断面性能表

全断面積	単位質量	換算質量	断面2次モーメント	断面2次半径	断面係数	材質
cm	kg/m	kg/m ²	cm ⁴	cm	cm ²	JISG3302
7.34	6.03	11.20	4.79	0.808	2.25	SPGC

品名 フックボルト 太さ 9mm

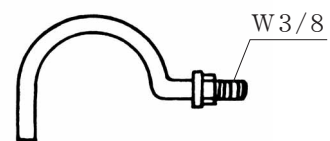



SHOEI

安全鋼板

メッシュタイプ・仮設くくり戸

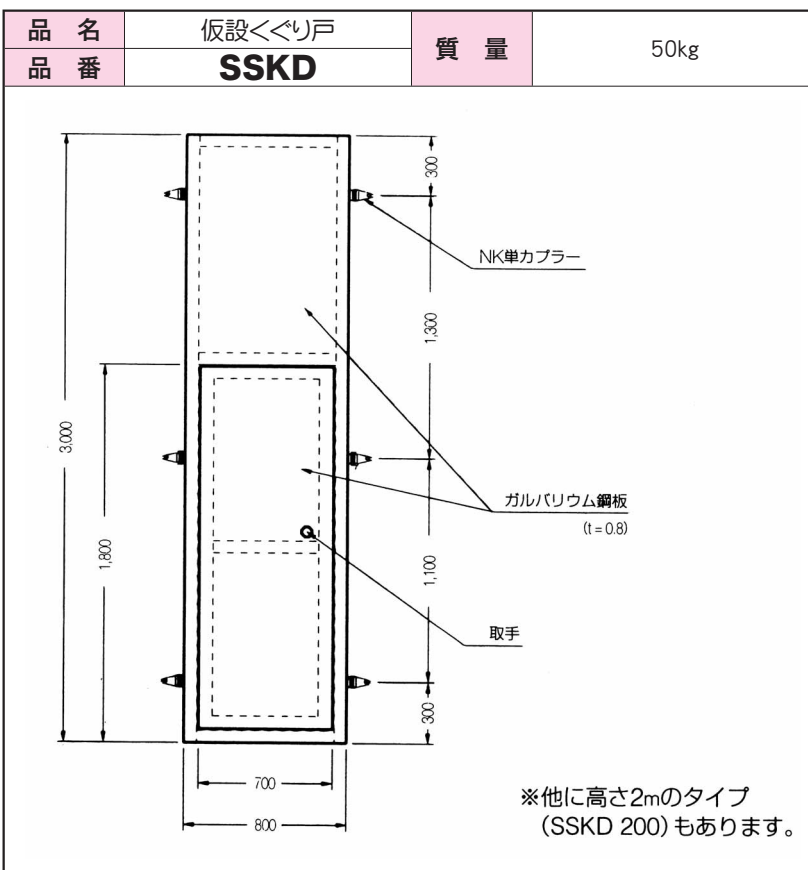
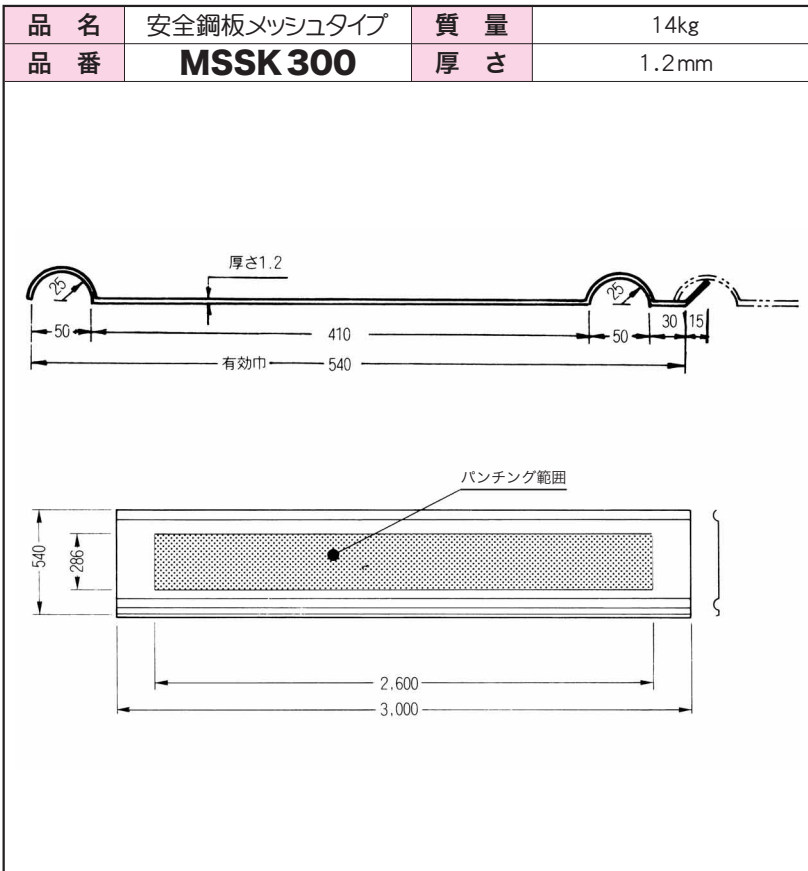



標準施工図

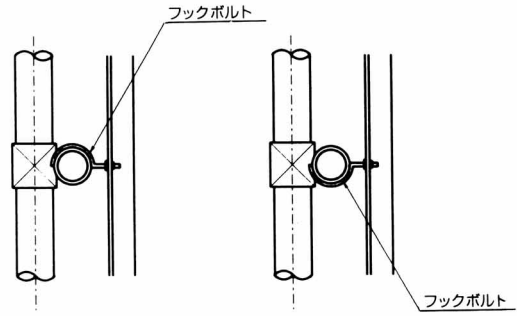
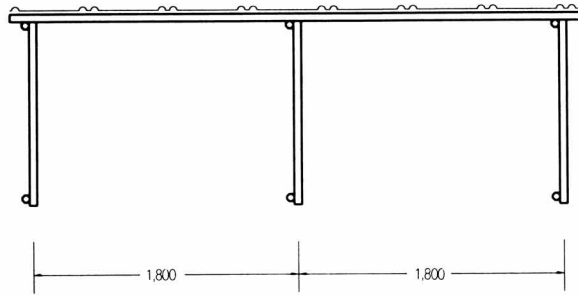

上部・下部の取付け

中央部取付け

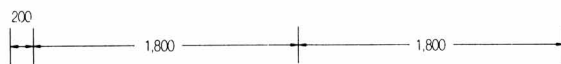
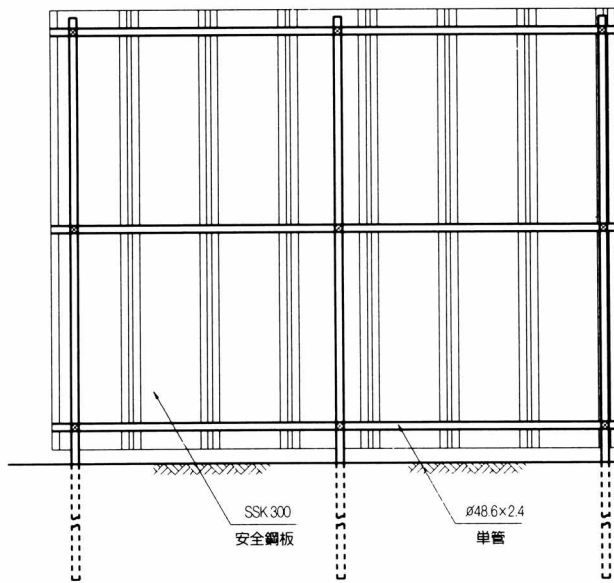
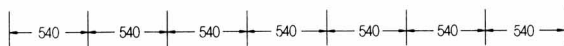

立面図

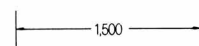
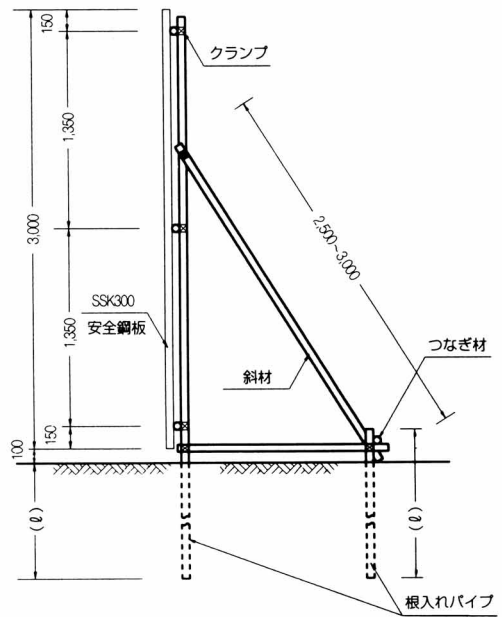

断面図